

# MIRRORSTONE

INFRARED HEATING



**MS-THC-12J / MS-THC-18J /  
MS-THC-24J / MS-THC-30J-**



**MS-THC-12D / MS-THC-18D /  
MS-THC-30J / MS-THC-30D-**



**Before using your heater for the first time**

Please read all the instructions in this manual carefully, even if you have prior experience of using an infrared heater. This manual should be kept in a safe place for future reference.

Should you need to make any kind of warranty claim with the manufacturer, you will need to make note of the complete model number (located on the product card at the back of the heater), the date on which you received the product, and your receipt of purchase.

The various ratings listed on the product card are based on specific loading tests performed in a controlled environment. Normal usage or use with other electrical equipment may result in different ratings.

Upon switching the heater on for the first time, you may notice a distinct smell and light smog.

Please be aware that this is completely normal – this is simply the protective oils used on the element to protect it during production and transport burning off. Once the heater has been on in an open environment, any smell or smog will disappear over a short period of time.

**Important Safeguards**

Please abide by the following safety precautions when using the heater, in order to minimise the risk of fire, electrical shock, injury or property damage:

- Please read all the instructions in this manual carefully, and keep it in a safe place for future reference.
- Use only the voltage specified on the product card located at the back of the heater.
- Do not obstruct the front of the heater, or block the entry or exit of any airflow. There should be a clearance of at least 1 metre around the front and sides of the heater.
- Do not use the product in close proximity to any other radiant heat source.
- Do not use the product in close proximity to gasoline, paint or any other highly flammable liquids.
- Take extra care to ensure that the heater has been off for at least 1 hour before touching it with bare skin or moving it to another location.
- Keep the heater away from all kinds of liquid, ensuring that it does not become immersed in any liquid, as this could create an electrical shock.
- Do not use the heater if the plug, power cord, or connectors become damaged in any way. In the event of such an occurrence, please return the heater to a qualified electrician for examination, adjustment, service or repair.
- Do not touch the appliance with wet hands.
- The most common cause of overheating is dust or fluff deposits getting stuck in the heater. You can prolong the life and ensure the safety of your heater by disconnecting it regularly and vacuum cleaning the air vents and grilles.
- Ensure that the product is installed away from windows as any rain may cause an electrical shock.
- When cleaning the heater, only use a soft, damp cloth, and always ensure that the heater has been disconnected from the mains before cleaning. Do not use an abrasive cleaning cloth.
- Do not connect to the mains supply until the heater has been completely installed.
- Do not use the heater in the immediate vicinity of any baths, showers, swimming pools, or any other areas where there is an exceptionally large concentration of water.

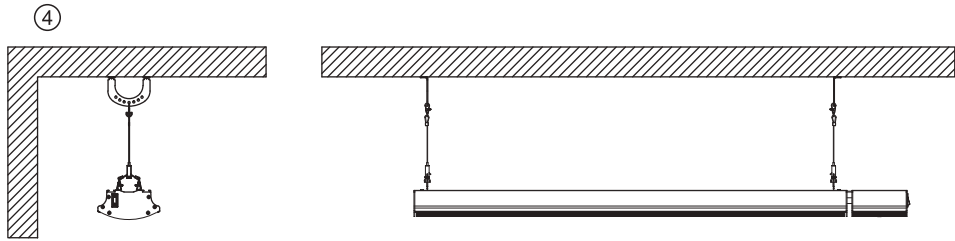

(Spare parts need to be bought separately)

For suspended installation, the heater will hook up to the suspension cables and hang from the ceiling, as shown in Fig. 4.

### Warning

1. Please ensure that the heater is installed correctly, as per this instruction manual, and that it is facing the correct way.
2. The heater should be installed in a place where the controls cannot be used by someone who is using a bath or a shower.
3. The heater should not be installed directly above an electrical socket.
4. Please consult a qualified electrician if there is any damage to the power cord on your heater.
5. Before moving your heater, make sure it has sufficiently cooled down.
6. Do not leave young or vulnerable people like the elderly or the disabled unsupervised in a room when the heaters are in use.
7. Please ensure that the heater is not installed in close proximity to furniture, curtains or any other objects in the home that could be flammable.

When disposing of your heater, please use your local rubbish collection facilities rather than using your general waste services. Contact your local council for information regarding these collection services. Should the heater be disposed of in a landfill or dump, there is a risk of hazardous substances leaking into the groundwater, which then has a knock-on effect on the local food chain, potentially damaging your health and well-being.



- Please let the surface of the heater cool down before moving it.
- Do not tamper with the power cord while the heater is on.
- Using an extension cord with this product is not recommended.
- Please ensure that the power cord is disconnected when the heater is not on.
- This heater isn't suitable for use near long pile carpets or flokati rugs.
- Do not allow the power cord to come into contact with the heater when it is on.
- Do not leave the power cord loose around walkways or corridors, as this could be a tripping hazard.
- Do not twist, kink or wrap the cord around the heater, as this may cause the insulation to weaken and split.
- Do not store the heater away while it is still hot.
- The heater is not to be used by young children, the elderly or the disabled without supervision.
- Do not install the heater directly above an electrical socket.
- Do not use this heater with more than one programmer, timer, thermostat, or any other device that switches the heater on and off automatically (including the built-in thermostat on the remote controllable version).
- The cover and casing are designed to protect the heating elements inside the heater, and should not be tampered with or opened under any circumstances.
- Please adhere to the safety precautions detailed in this manual, in order to prevent any fire, electrical hazards or injuries.
- The heater may be operated by children over the age of 8, those who suffer from reduced physical, sensory or mental capabilities, provided they are supervised or complete understanding of the operational and general hazards involved with using the heater. Children should not play with the heater, and should not carry out any cleaning or maintenance of the heater.
- Children younger than 8 should not use the heater in any capacity, whether they are supervised or unsupervised.
- The outer surface of the heater can get very hot and cause burns if contact is made with the skin for prolonged periods of time. Please pay attention when children or vulnerable people are present.
- The heater should be installed at a minimum of 2.2 metres from the floor.
- Should the power cord become damaged, it must be returned to the manufacturer, or be repaired by a qualified electrician.
- The heater should not be used in confined spaces with occupants who are unable to leave the room on their own.

## Product Instructions for the Remote Controllable Variants



### Product Size

Model	Power	Length(mm)	Width(mm)	Height(mm)
MS-THC-12D	1200W	940	150	65
MS-THC-18D	1800W	1240	150	65
MS-THC-30J	2400W	1540	150	65
MS-THC-30D-	3000W	1840	150	65

### Circuit Diagram

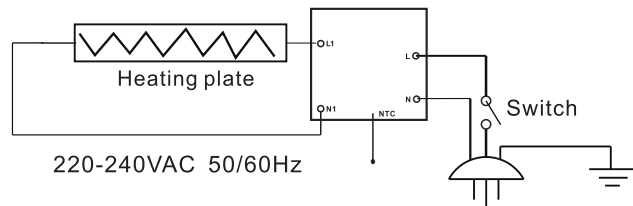

### Remote Control

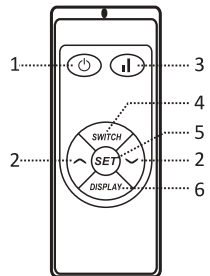

1. Power on/off button
2. Up/Down buttons
3. High/Low switch buttons
4. Switch button
5. Set button
6. Display button

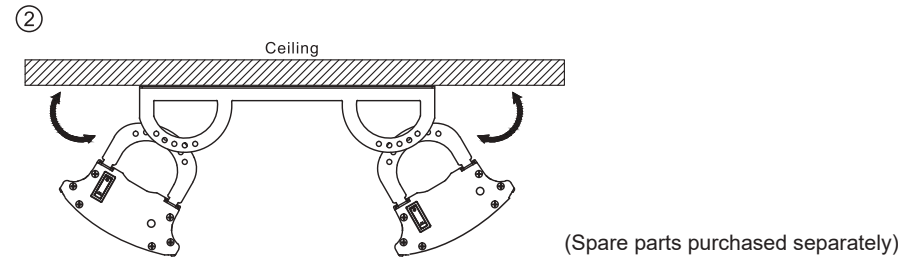

For a double installation, both heaters are mounted through a connecting frame, which is installed on the ceiling, as shown in Fig. 2.

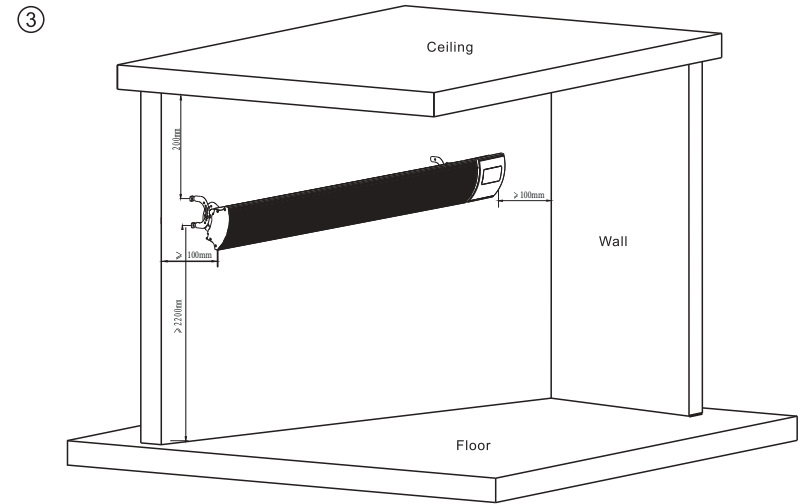

For wall installations, the height from the floor should be at least 2.2 metres, as shown in Fig. 3.

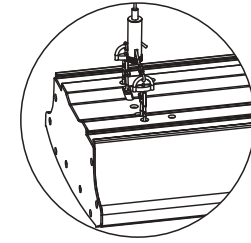
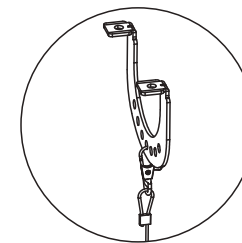

When you require any service or repair, contact your local service centre or qualified electrician.

### 5. Replacement of Power Cord

Should the power cord become damaged, it must be replaced by a qualified electrician or the manufacturer.

### 6. Child Supervision

This heater is not intended for use by children or vulnerable people without supervision.

## INSTALLATION GUIDE

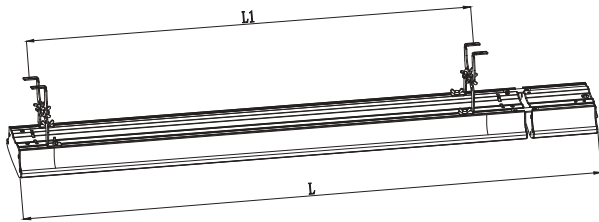

Model	L(mm)	L1(mm)
MS-THC-12J	940	707
MS-THC-18J	1240	1007
MS-THC-24J	1540	1307
MS-THC-30J-	1840	1607

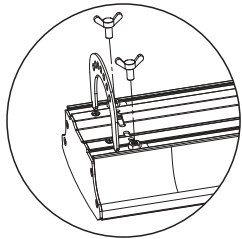

A

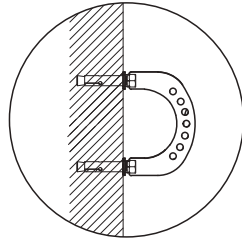

B

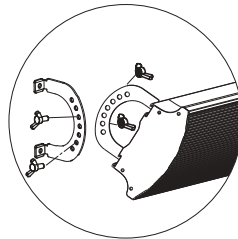

C

Step one: Use the screws provided to install two of the brackets to the back of the heater, as shown in Fig. A.

Step two: Use the screws provided to install two of the brackets to the wall or ceiling, as shown in Fig. B.

Step three: Connect the brackets on the back of the heater to the brackets on the wall at your desired angle, using the wing nuts provided to fix them, as shown in Fig. C.

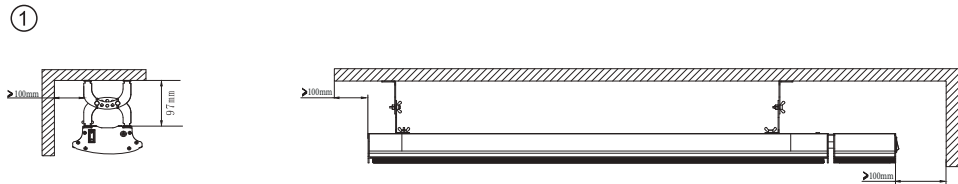

Ceiling installation: the distance from the wall to the side of the heater should be at least 100mm, as shown in Fig. 1.

1. Before first use, please read the following points carefully.
  - 1.1. When removing the heater from the box, please take care to ensure that you do not damage the heater, and that you retain the box for storage purposes.
  - 1.2. Install the heater according to the instructions provided in this manual.
  - 1.3. The heater should be connected to its own power supply, and should not share a circuit with other high-power appliances, otherwise the circuit may overload.
2. Switching the heater on:
  - 2.1. Please ensure that the power switch located on the side of the heater is in the Off position before connecting to your electrical supply.
  - 2.2. To switch the heater on, put the power switch on the side of the heater into the On position. You will see the display light up on the front of the heater, which will display the current room temperature.
  - 2.3. To lock the Heater, press the "Switch" button, followed by the "On/Off" button. You will see a square lock icon on the screen, and none of the buttons will be operational while it is locked. To unlock the heater, you can simply repeat the process, pressing "Switch" followed by "On/Off".
  - 2.4. To toggle the screen on and off, press the "Display" button. The screen will power off, however there will still be a power indicator on screen to tell you that the heater is operational. To toggle the screen back on, simply press the "Display" button again.
  - 2.5. To use the automatic temperature control feature, press the "Set" button. You will see a temperature flashing on screen that you can adjust up and down using the "Up/Down" buttons. The maximum temperature you can set is 45°C, and the lowest temperature you can set is 5°C. If your desired temperature is lower than the current room temperature, the heater will not emit any heat, and if the desired temperature is higher than the current room temperature, the heater will begin emitting heat, and you will see the lights appear on the screen below the temperature display.
  - 2.6. To use the timer setting, press the "Set" button again while you are setting your desired temperature. You will see a "00" flashing on the screen, along with a clock icon on the screen. Use the "Up/Down" buttons on the remote to change the amount of time in hours that you would like the heater to be operational for. You can select any duration between 0 hours and 24 hours, in 1-hour increments. Once you are happy with your selection, simply leave the heater for a few seconds, and it will save your settings.
  - 2.7. By default, the heater comes with open window detection, where if the heater detects a drop in temperature by 3°C or more within a 2 minute time window, it will automatically switch off to conserve energy and increase efficiency. When this happens, the display will flash and there will be a clicking sound. To override this, simply operate the remote and switch the heater back on.
  - 2.8. To reset the Wi-Fi settings on the heater, press "Switch", then "High/Low Switch", then "Up" all within 5 seconds. You will know when it has been reset, as the Wi-Fi symbol will start flashing rapidly on the screen.
  - 2.9. To toggle between High Power and Low Power, press the "High/Low Switch" button. The indicator on the screen will switch from a full sun (High Power) to a half sun (Low power) to tell you which setting it is on.
3. To put the heater in standby, press the "On/Off" button once. The display will switch off except for the current room temperature and Wi-Fi symbol. Press the "On/Off" button again to switch the heater back on.
4. Please be aware that this heater will get hot whilst in use. To prevent injury, do not touch the heater when it is on, and allow at least 1 hour after disconnecting from the power supply before touching it.
5. For repairs and servicing, please get in contact with your local repair centre or a qualified electrician.
6. If there is any damage to the power cord, you must stop using the heater immediately, and get it repaired from either a local repair centre or a qualified electrician.
7. This heater is not to be used by children or other vulnerable people without supervision from an adult.

## Installation Guide

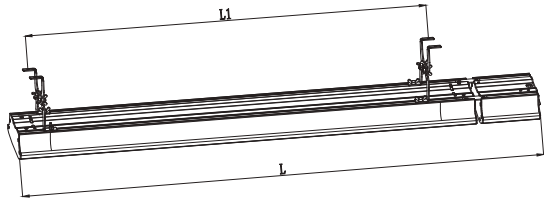

Model	L(mm)	L1(mm)
MS-THC-12J	940	707
MS-THC-18J	1240	1007
MS-THC-24J	1540	1307
MS-THC-30J-	1840	1607

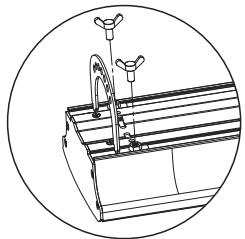

A

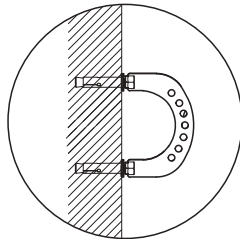

B

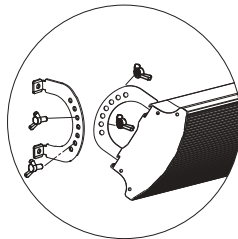

C

Step one: Use the screws provided to install two of the brackets to the back of the heater, as shown in Fig. A.

Step two: Use the screws provided to install two of the brackets to the wall or ceiling, as shown in Fig. B.

Step three: Connect the brackets on the back of the heater to the brackets on the wall at your desired angle, using the wing nuts provided to fix them, as shown in Fig. C.

## Product Instructions for Non-Remote Controllable

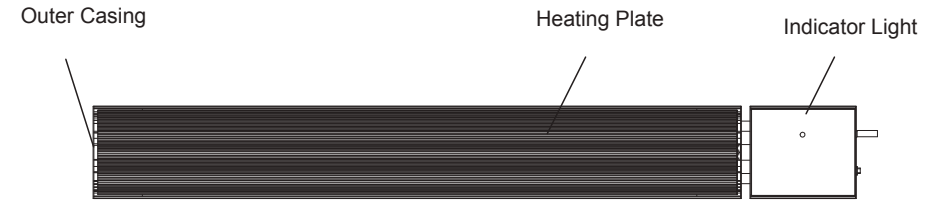

## Product Size

Model	Power	Length (mm)	Wide (mm)	High (mm)
MS-THE-12JB	1200W	940	150	65
MS-THE-18JB	1800W	1240	150	65
MS-THE-24JB	2400W	1540	150	65
MS-THE-30JB	3000W	1840	150	65

## Circuit Diagram

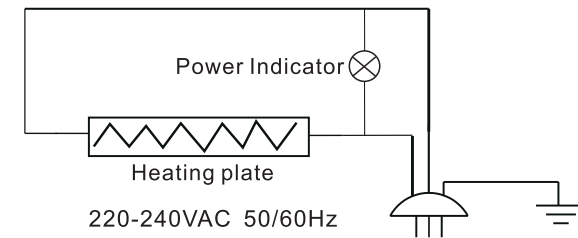

1. Before first use, please read this manual carefully.
  - 1.1. When removing the heater from the box, please take care to ensure that you do not damage the heater, and that you retain the box for storage purposes.
  - 1.2. Install the heater according to the instructions provided in this manual.
  - 1.3. The heater should be connected to its own power supply, as it should not share a circuit with other high-power appliances, otherwise the circuit may overload.
2. Upon connecting the heater to a power supply, the heater will switch on.
3. Please be aware that the front of the heater does get very hot when in operation, so please take care to ensure you do not touch the heater when it is on.



Figure4



Figure5



Figure6



Figure7



Figure8

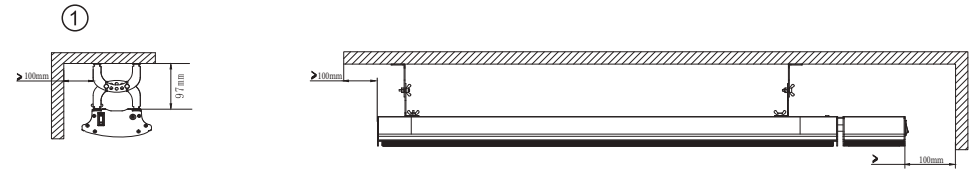

For ceiling installation: the distance between the side of the heater and the wall should be at least 100mm, as shown in Fig. 1.

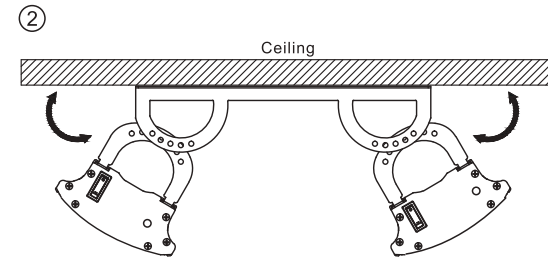

For a double installation, both heaters are mounted through a connecting frame, which is installed on the ceiling, as shown in Fig. 2.

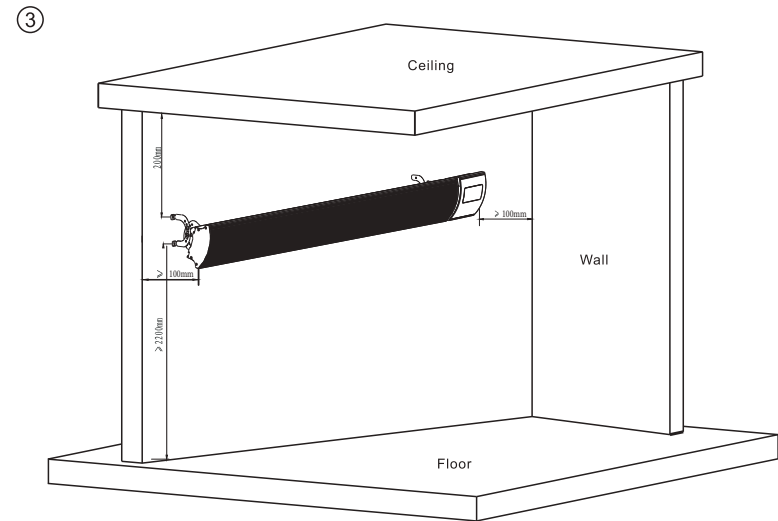

For wall installations, the height from the floor should be at least 2.2 metres, as shown in Fig. 3.

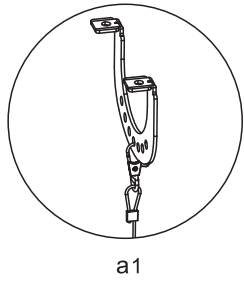

a1

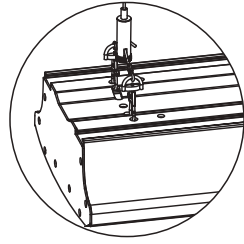

b1

④

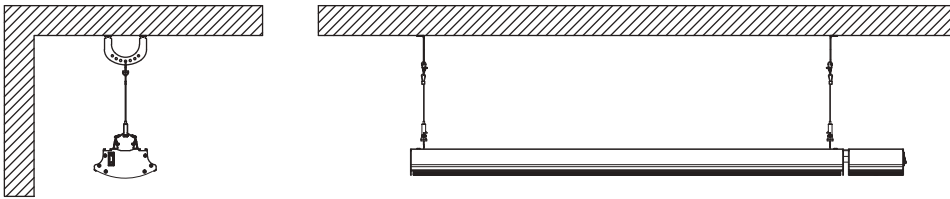

(Spare parts purchased separately)

For suspended installation, the heater will hook up to the suspension cables and hang from the ceiling, as shown in Fig. 4.

### 1. Download The App

Both Apple and Android users can scan the QR code below to download the Smart Life app.



### 2. Using The App

After downloading the app (Fig. 1), you will be required to create an account, either using your email address or your mobile telephone number. Once done (Fig. 2), click on “Add Device”. From here (Fig. 3), click “Small Home Appliances” on the left hand menu, scroll down and select “Oil Heater” (Fig. 4). Check that the Wi-Fi symbol light is flashing on the heater (Fig. 5), after which you will be required to enter your Wi-Fi network name and password (Fig. 6). After this, your app should connect to your heater (Fig. 7), and you will be able to control it using the Smart Life app (Fig. 8).

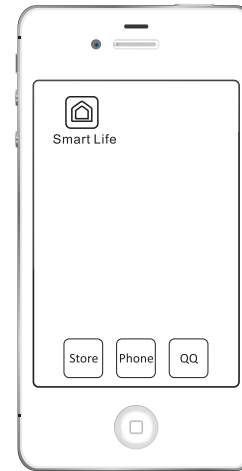

Figure 1



Figure 2

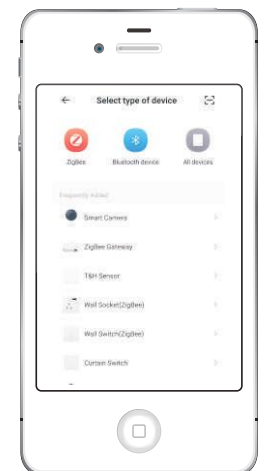

Figure3